



■ Features

- Universal AC input / Full range
- Class II power unit, no FG
- Built-in active PFC function
- High efficiency up to 90.5%
- No load power consumption <0.15W
- Energy efficiency Level VI
- Comply with EISA 2007/DoE,NRCan
- Fully isolated plastic case
- Fanless design, cooling by free air convection
- Protections: Short circuit / Over current / Over voltage / Over temperature
- UL LISTED, suitable for dry and damp locations
- 5 years warranty

■ Applications

- Indoor LED lighting
- LED decorative lighting
- LED office lighting
- General electronic products in dusty or humid environment

■ Description

OWA-120U is one 120W single-output external LED power supply series. Pairing the North American type of AC plug and the prevailing DC connectors, OWA-120U, working like an adaptor, simplifies the connection with LED lighting fixtures without extra wiring efforts. The entire series is certified with the “UL LISTED” for dry and damp locations.

As a class II (no FG) design, the enclosure of OWA-120U is a 94V-0 flame retardant plastic case. The interior is fully potted with silicone that enhances the heat dissipation. With the working efficiency up to 90.5%, OWA-120U is cooled by free air convection; the working temperature ranges from -40°C to +70°C.

■ Model Encoding

OWA - 120U - 12

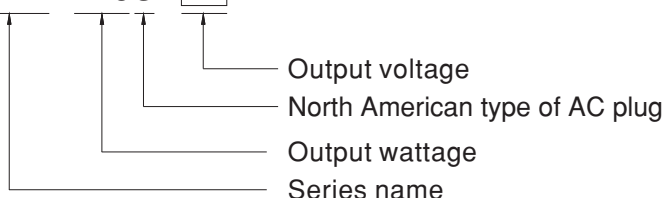



SPECIFICATION

| MODEL | | OWA-120U-12 | OWA-120U-15 | OWA-120U-20 | OWA-120U-24 | OWA-120U-30 | OWA-120U-36 | OWA-120U-42 | OWA-120U-48 | OWA-120U-54 | |
|---|---|---|------------------|----------------|-------------|-------------|-------------|-------------|-------------|-------------|-------|
| OUTPUT | DC VOLTAGE | 12V | 15V | 20V | 24V | 30V | 36V | 42V | 48V | 54V | |
| | CONSTANT CURRENT REGION | 7.2 ~ 12V | 9 ~ 15V | 12 ~ 20V | 14.4 ~ 24V | 18 ~ 30V | 21.6 ~ 36V | 25.2 ~ 42V | 28.8 ~ 48V | 32.4 ~ 54V | |
| | RATED CURRENT | 10A | 8A | 6A | 5A | 4A | 3.4A | 2.9A | 2.5A | 2.3A | |
| | RATED POWER | 120W | 120W | 120W | 120W | 120W | 122.4W | 121.8W | 120W | 124.2W | |
| | RIPPLE & NOISE (max.) Note.2 | 150mVp-p | 150mVp-p | 150mVp-p | 150mVp-p | 200mVp-p | 200mVp-p | 250mVp-p | 250mVp-p | 350mVp-p | |
| | VOLTAGE TOLERANCE Note.3 | ±4.0% | ±4.0% | ±4.0% | ±4.0% | ±3.0% | ±2.0% | ±1.0% | ±1.0% | ±1.0% | |
| | LINE REGULATION | ±0.5% | ±0.5% | ±0.5% | ±0.5% | ±0.5% | ±0.5% | ±0.5% | ±0.5% | ±0.5% | |
| | LOAD REGULATION | ±2.0% | ±1.5% | ±1.0% | ±0.5% | ±0.5% | ±0.5% | ±0.5% | ±0.5% | ±0.5% | |
| | SETUP, RISE TIME Note.4 | 500ms, 80ms at 95% load 230VAC / 115VAC | | | | | | | | | |
| HOLD UP TIME (Typ.) | 16ms at full load 230VAC / 115VAC | | | | | | | | | | |
| INPUT | VOLTAGE RANGE | 90 ~ 264VAC | | 127 ~ 370VDC | | | | | | | |
| | FREQUENCY RANGE | 47 ~ 63Hz | | | | | | | | | |
| | POWER FACTOR (Typ.) | PF>0.97/115VAC, PF>0.96/230VAC at full load | | | | | | | | | |
| | TOTAL HARMONIC DISTORTION | THD< 20% when output loading ≥60% at 115VAC/230VAC | | | | | | | | | |
| | EFFICIENCY (Typ.) | 115VAC | 87% | 88% | 89% | 89.5% | 89% | 89% | 89.5% | 89.5% | 89.5% |
| | | 230VAC | 87.5% | 89% | 90% | 90.5% | 90% | 90% | 90.5% | 90.5% | 90.5% |
| | AC CURRENT (Typ.) | 1.3A / 115VAC | | 0.65A / 230VAC | | | | | | | |
| | INRUSH CURRENT (Typ.) | COLD START 30A(twidth=520μs measured at 50% Ipeak) at 115VAC COLD START 60A(twidth=520μs measured at 50% Ipeak) at 230VAC | | | | | | | | | |
| MAX. NO. of PSUs on 16A CIRCUIT BREAKER | 4 units (circuit breaker of type B) / 6 units (circuit breaker of type C) at 230VAC | | | | | | | | | | |
| LEAKAGE CURRENT | <0.125mA / 120VAC | | <0.25mA / 240VAC | | | | | | | | |
| PROTECTION | OVER CURRENT | 95 ~ 108% Protection type : Constant current limiting, recovers automatically after fault condition is removed | | | | | | | | | |
| | SHORT CIRCUIT | Hiccup mode, recovers automatically after fault condition is removed | | | | | | | | | |
| | OVER VOLTAGE | 15 ~ 17V | 17.5 ~ 21V | 23 ~ 27V | 28 ~ 34V | 34 ~ 40V | 41 ~ 46V | 46 ~ 54V | 54 ~ 60V | 59 ~ 66V | |
| | OVER TEMPERATURE | Shut down o/p voltage, re-power on to recover | | | | | | | | | |
| ENVIRONMENT | WORKING TEMP. | -40 ~ +70°C (Refer to "Derating Curve") | | | | | | | | | |
| | WORKING HUMIDITY | 20 ~ 95% RH non-condensing | | | | | | | | | |
| | STORAGE TEMP., HUMIDITY | -40 ~ +80°C, 10 ~ 95% RH | | | | | | | | | |
| | TEMP. COEFFICIENT | ±0.03%/°C (0 ~ 50°C) | | | | | | | | | |
| | VIBRATION | 10 ~ 500Hz, 5G 12min./1cycle, period for 72min. each along X, Y, Z axes | | | | | | | | | |
| SAFETY & EMC | SAFETY STANDARDS | UL8750 listed, CSA C22.2 No. 250.13-12; IP67(for power body) approved | | | | | | | | | |
| | WITHSTAND VOLTAGE | I/P-O/P:3.75KVAC | | | | | | | | | |
| | ISOLATION RESISTANCE | I/P-O/P:100M Ohms / 500VDC / 25°C / 70% RH | | | | | | | | | |
| OTHERS | EMC EMISSION | Compliance to FCC Part15 | | | | | | | | | |
| | MTBF | 294.3K hrs min. MIL-HDBK-217F (25°C) | | | | | | | | | |
| | DIMENSION | 191*63*37.5mm | | | | | | | | | |
| NOTE | PACKING | 1.15Kg; 12pcs/14.8Kg/0.89CUFT | | | | | | | | | |
| | | 1. All parameters NOT specially mentioned are measured at 230VAC input, rated load and 25°C of ambient temperature. 2. Ripple & noise are measured at 20MHz of bandwidth by using a 12" twisted pair-wire terminated with a 0.1uf & 47uf parallel capacitor. 3. Tolerance : includes set up tolerance, line regulation and load regulation. 4. Length of set up time is measured at cold first start. Turning ON/OFF the power supply may lead to increase of the set up time. | | | | | | | | | |

Block Diagram

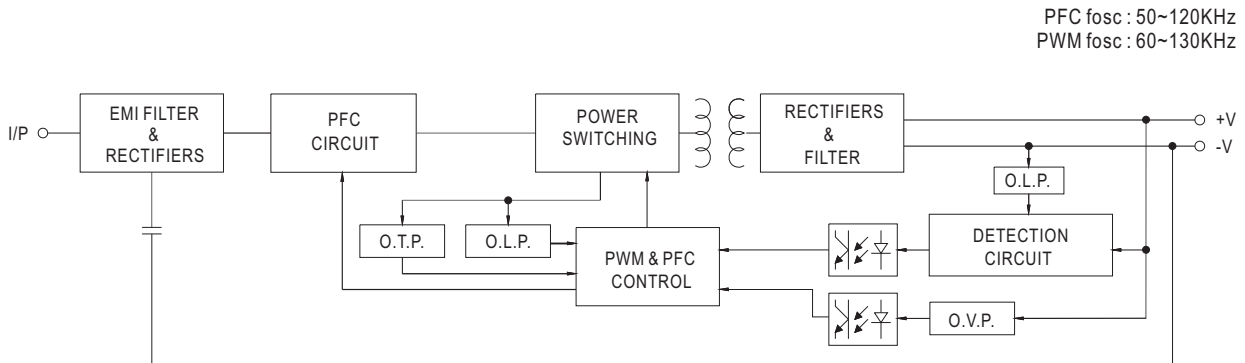

Derating Curve

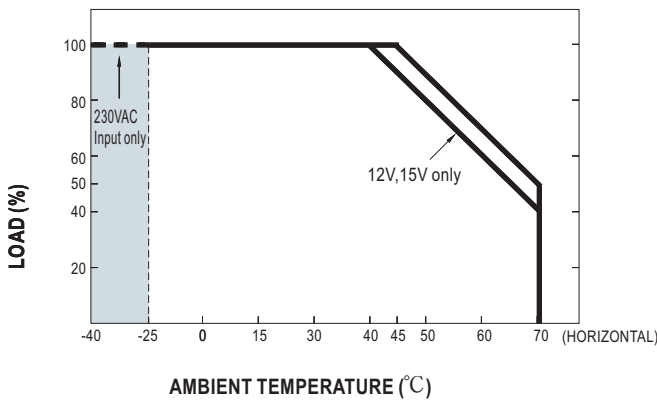

Static Characteristics

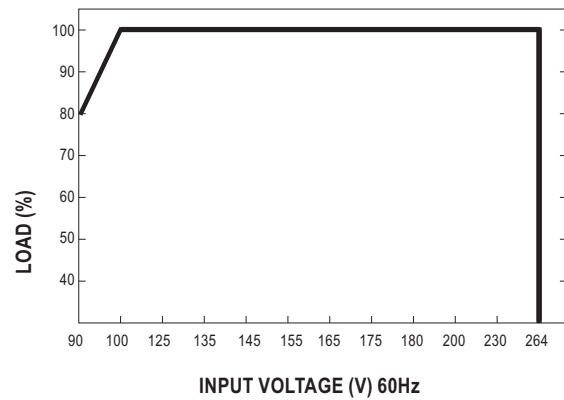

Power Factor Characteristic

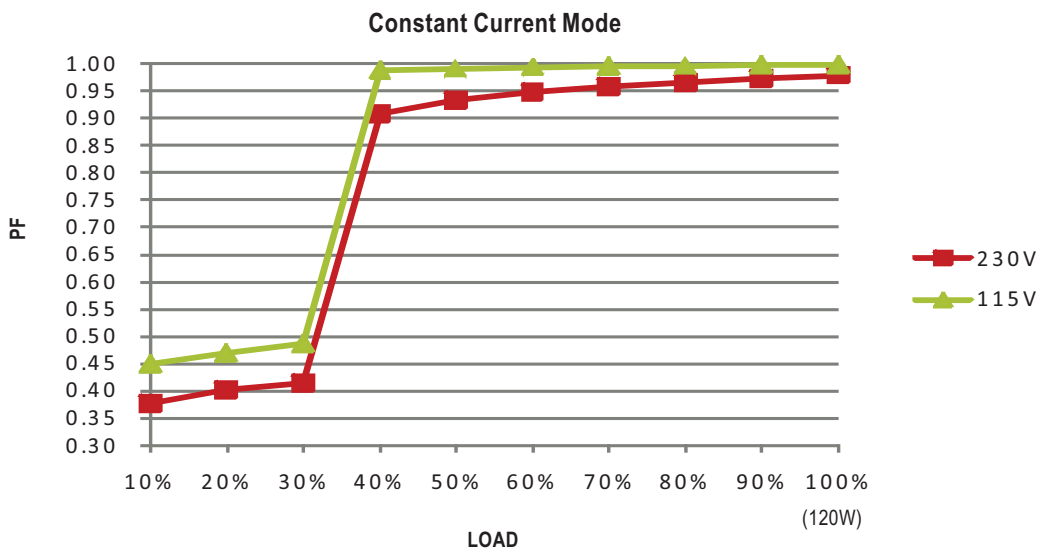

EFFICIENCY vs LOAD (48V Model)

OWA-120U series possess superior working efficiency that up to 90.5% can be reached in field applications.

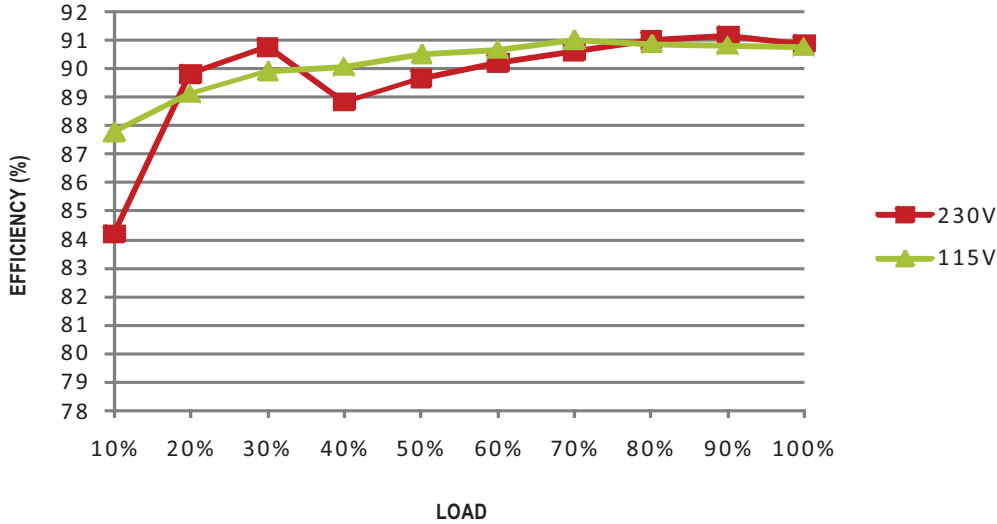

DRIVING METHODS OF LED MODULE

There are two major kinds of LED drive method, "direct drive" and "with LED driver".

A typical LED power supply may either work in "constant voltage mode (CV)" or "constant current mode (CC)" to drive the LEDs.

Mean Well's LED power supply with CV+ CC characteristic can be operated at both CV mode (with LED driver, at area (A) and CC mode (direct drive, at area (B)).

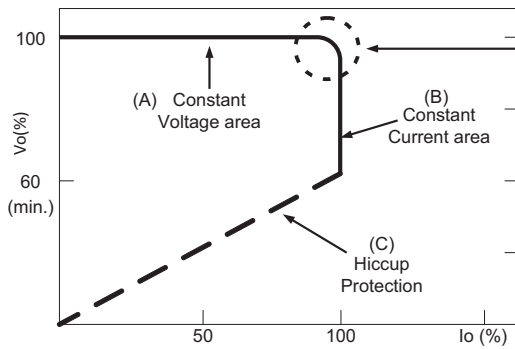

Typical LED power supply I-V curve

In the constant current region, the highest voltage at the output of the driver depends on the configuration of the end systems.

Should there be any compatibility issues, please contact MEAN WELL.

Mechanical Specification

Case No. PWM-120

Unit:mm

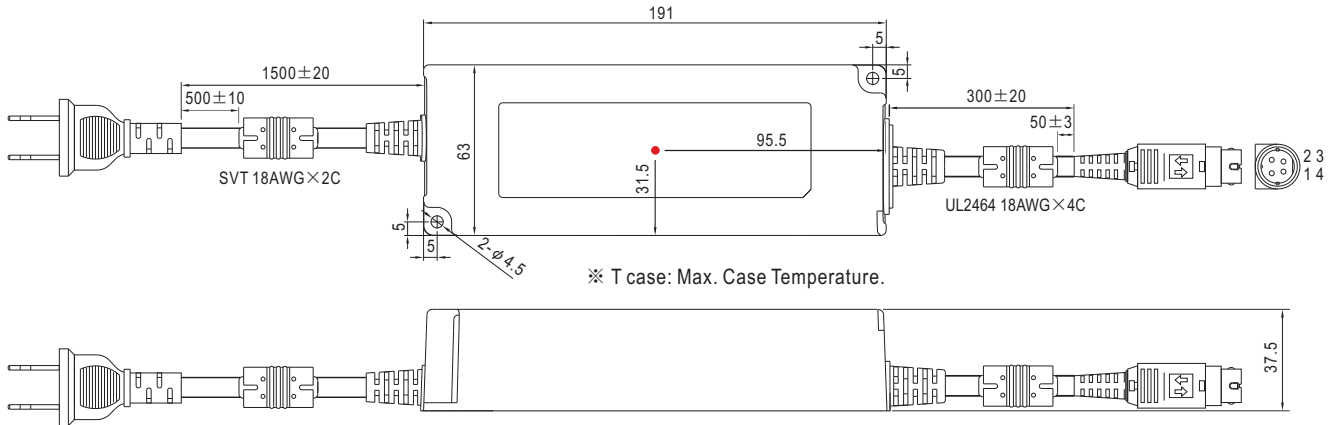

Input Plug Type

All models : NEMA 1-15p male plug

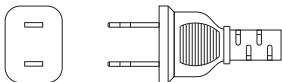

Output Plug Assignment

All models : power DIN 4 pins with lock type, KYCON KPPX-4P, or equivalent

| | PIN NO. | OUTPUT |
|--|---------|--------|
| | 1,4 | +V |
| | 2,3 | -V |

Recommend Mounting Direction

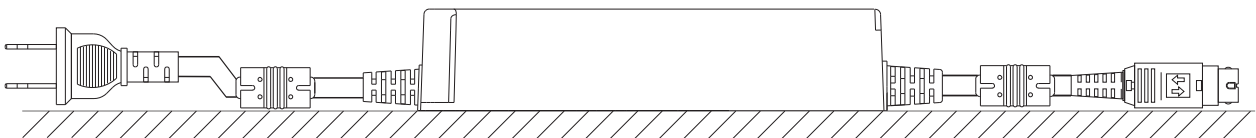

Installation Manual

Please refer to : <http://www.meanwell.com/webnet/search/InstallationSearch.html>